

Esquema de Montagem

Balcão Kaya

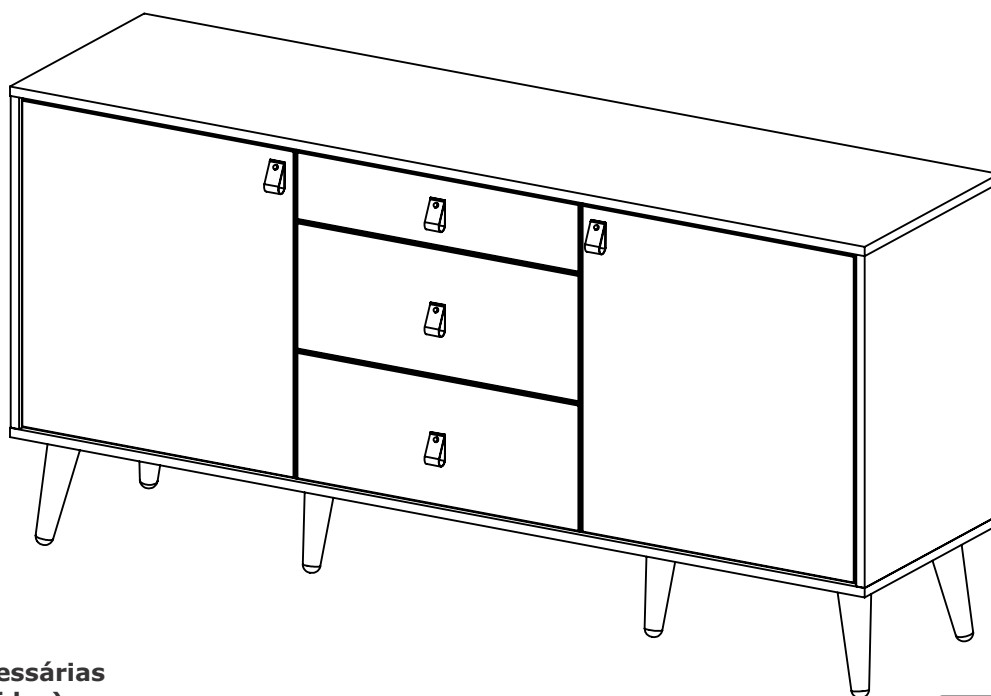

ferramentas necessárias
(não fornecidas)



chave phillips





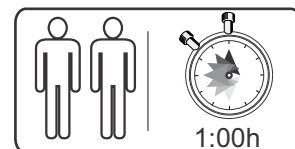





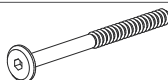
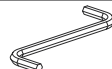

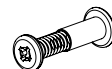



martelo de borracha

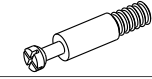
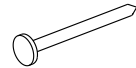

1:00h

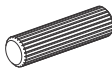
Ferragens

A		7 x 50	06	J		Chave Allen	10
B		4,0 x 30	12	K		Rv8	28
C		5/32 x 5/8 e Bucha	05	L		Corrediça 350mm	03
D		4,0 x 16	16	M		Puxador	05
E		3,5 x 14	24	N		Suporte Prateleira	08
F		3,0 x 16	28	O		Dobradiça	04
G		Rapid Minifix	22	P		Prego	08
H		Tambor Minifix	22	Q		Chapa União	08
I		Ø8x30	26	R		Ø6x30	06

Componentes

N.	Componentes	Quant.
01	Tampo	01
02	Fundo	01
03	Lateral	02
04	Traseiro Lateral	02
05	Traseiro Central	01
06	Divisão Direita	01
07	Divisão Esquerda	01
08	Prateleira	02
09	Porta Direita	01
10	Porta Esquerda	01
11	Pé Torneado	06
12	Traseira Gaveta Maior	01
13	Frente Gaveta Maior	02
14	Lateral Direita Gaveta Maior	02
15	Lateral Esquerda Gaveta Maior	02
16	Traseira Gaveta Maior	02
17	Fundo de Gaveta	03
18	Frente Gaveta Menor	01
19	Lateral Direita Gaveta Menor	01
20	Lateral Esquerda Gaveta Menor	01

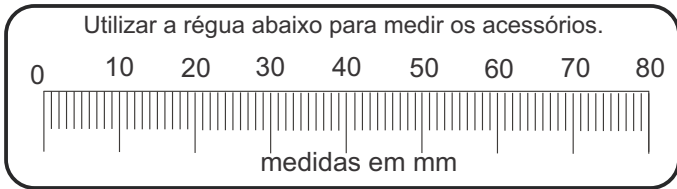
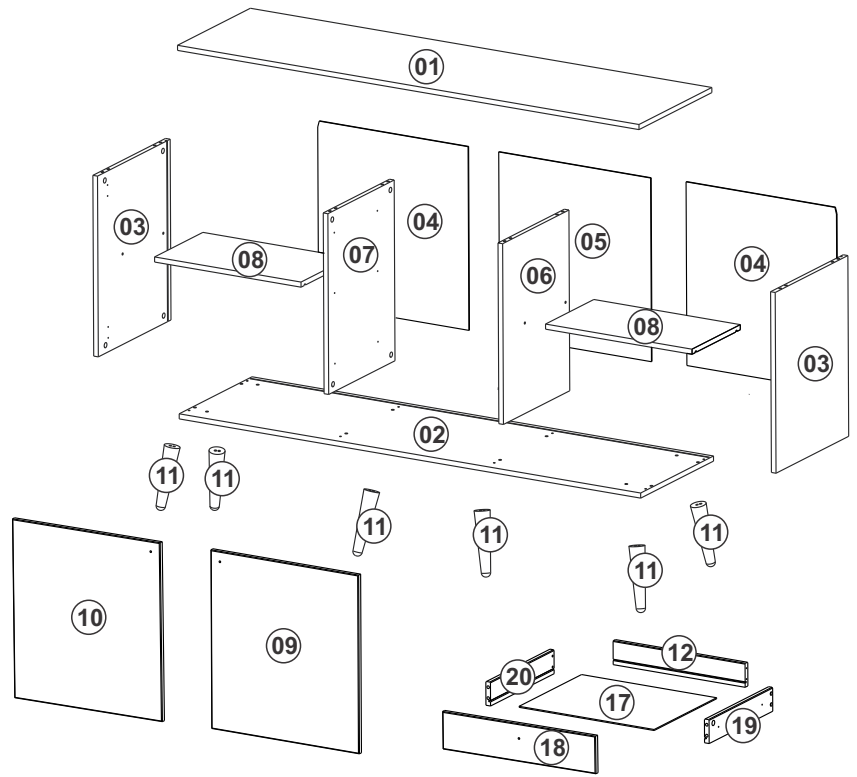

Atenção!
Forrar o chão com o papelão das embalagens para efetuar a montagem.

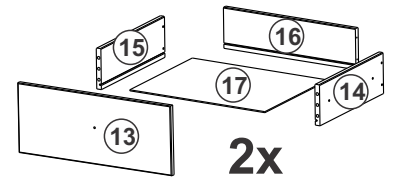

Passo 01

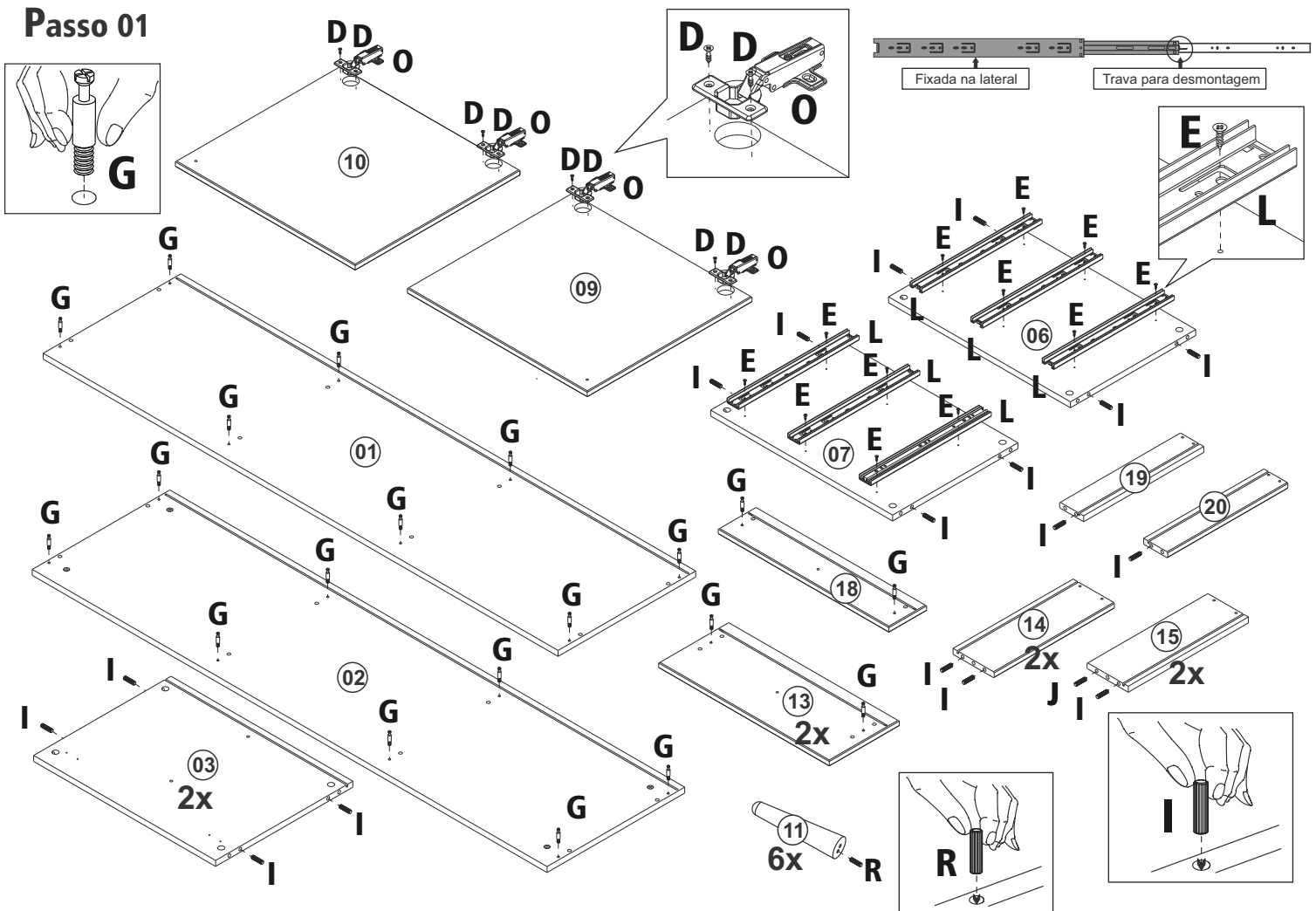

Passo 02

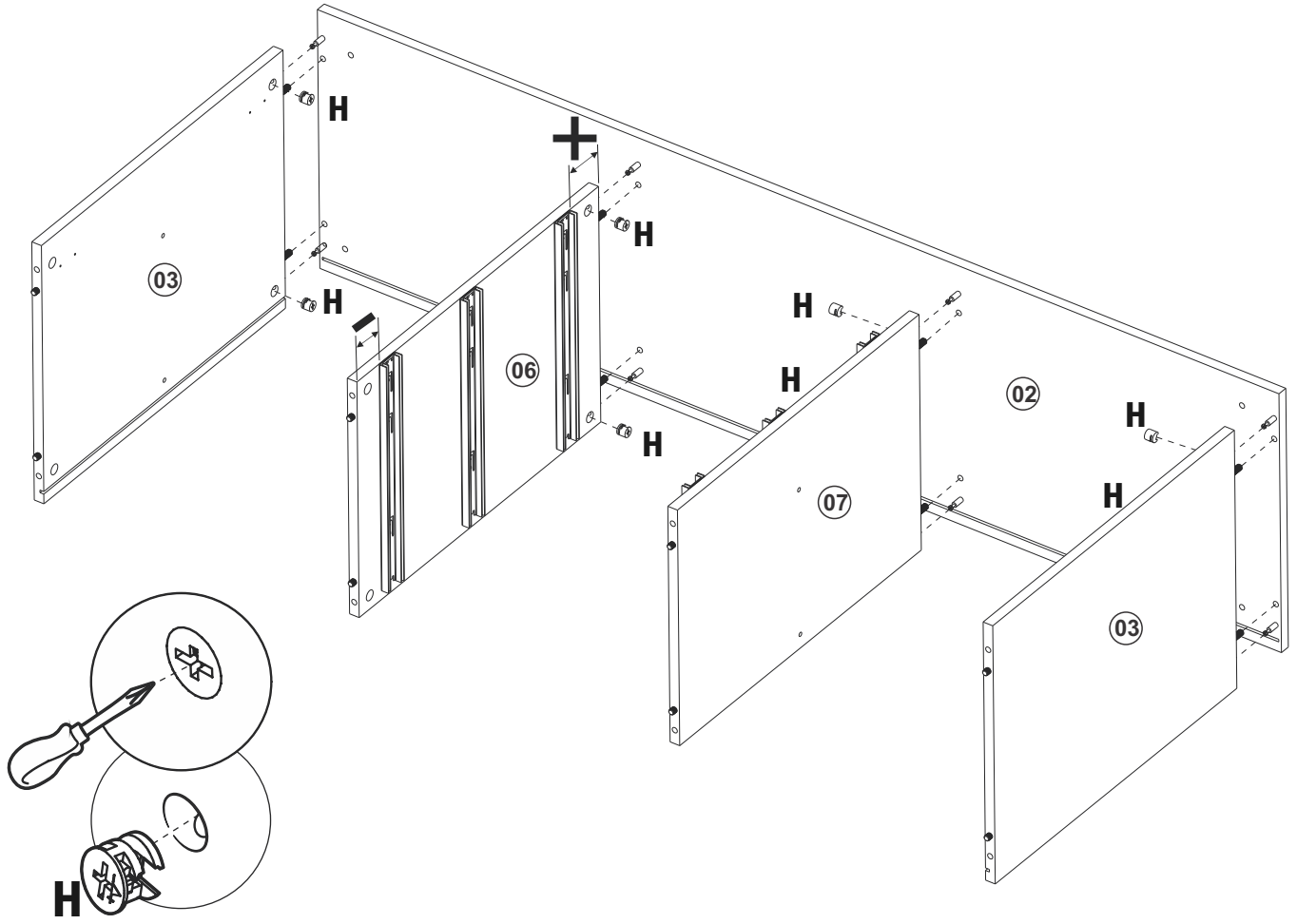

Passo 03

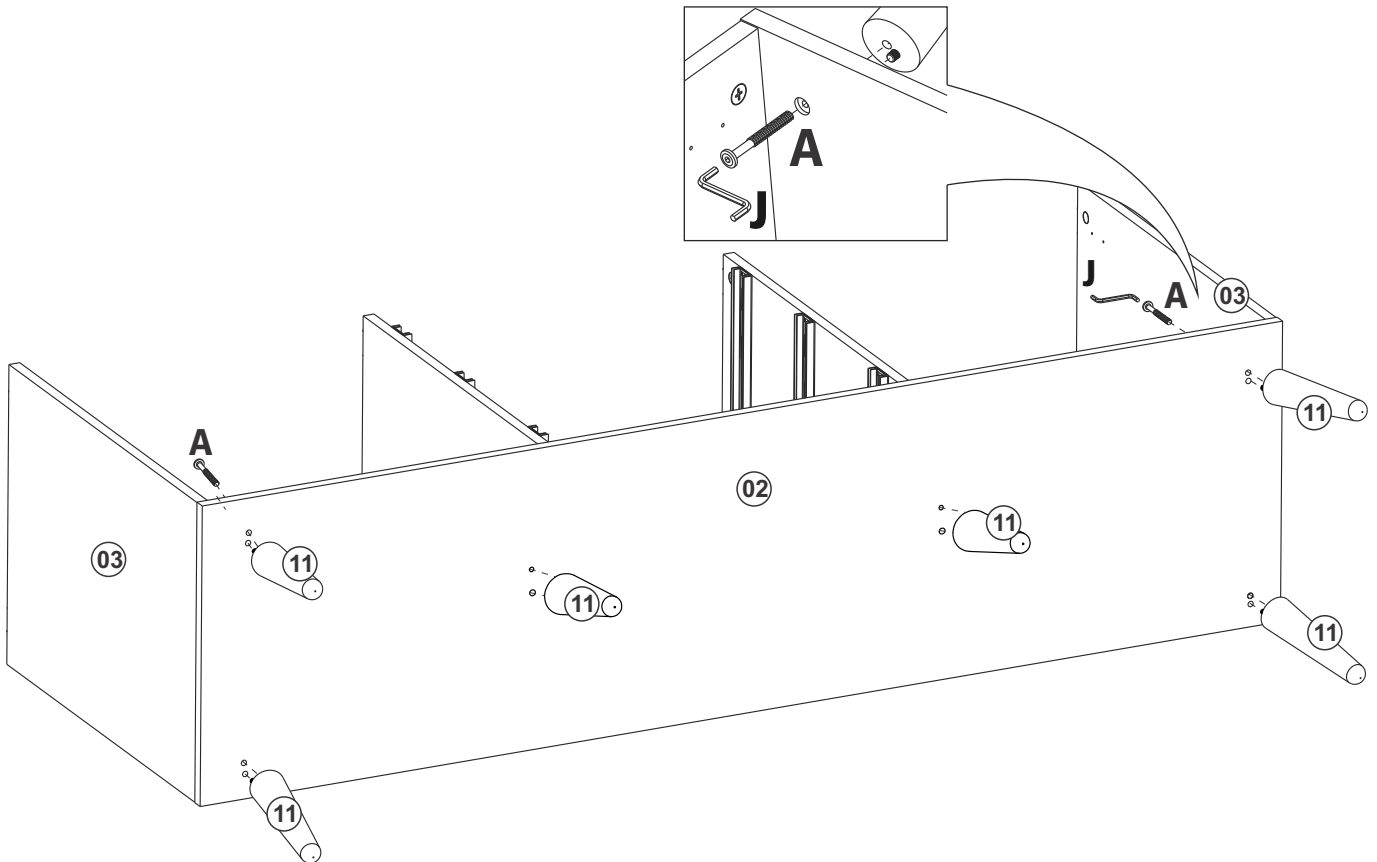

Passo 04

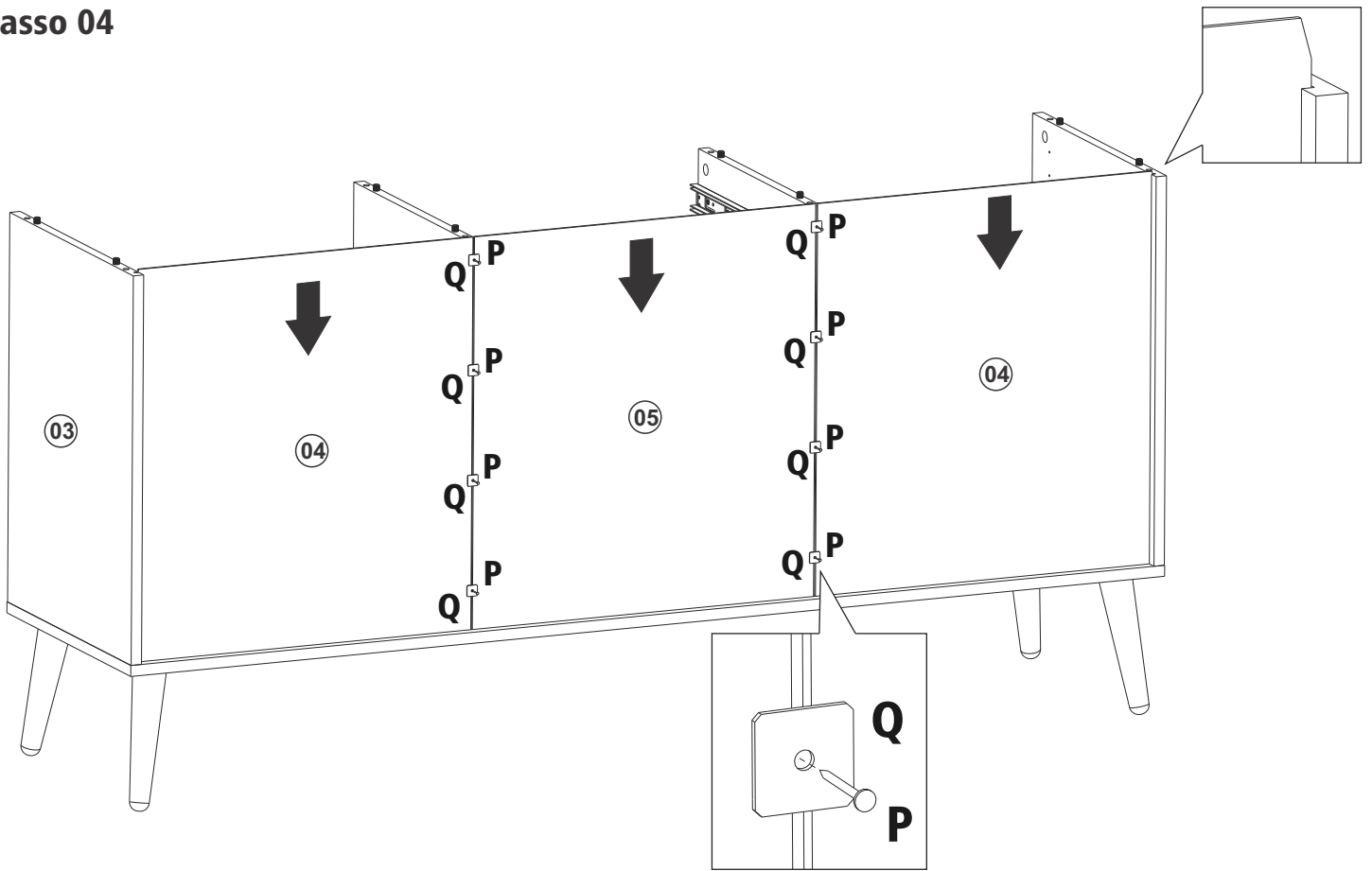

Passo 05

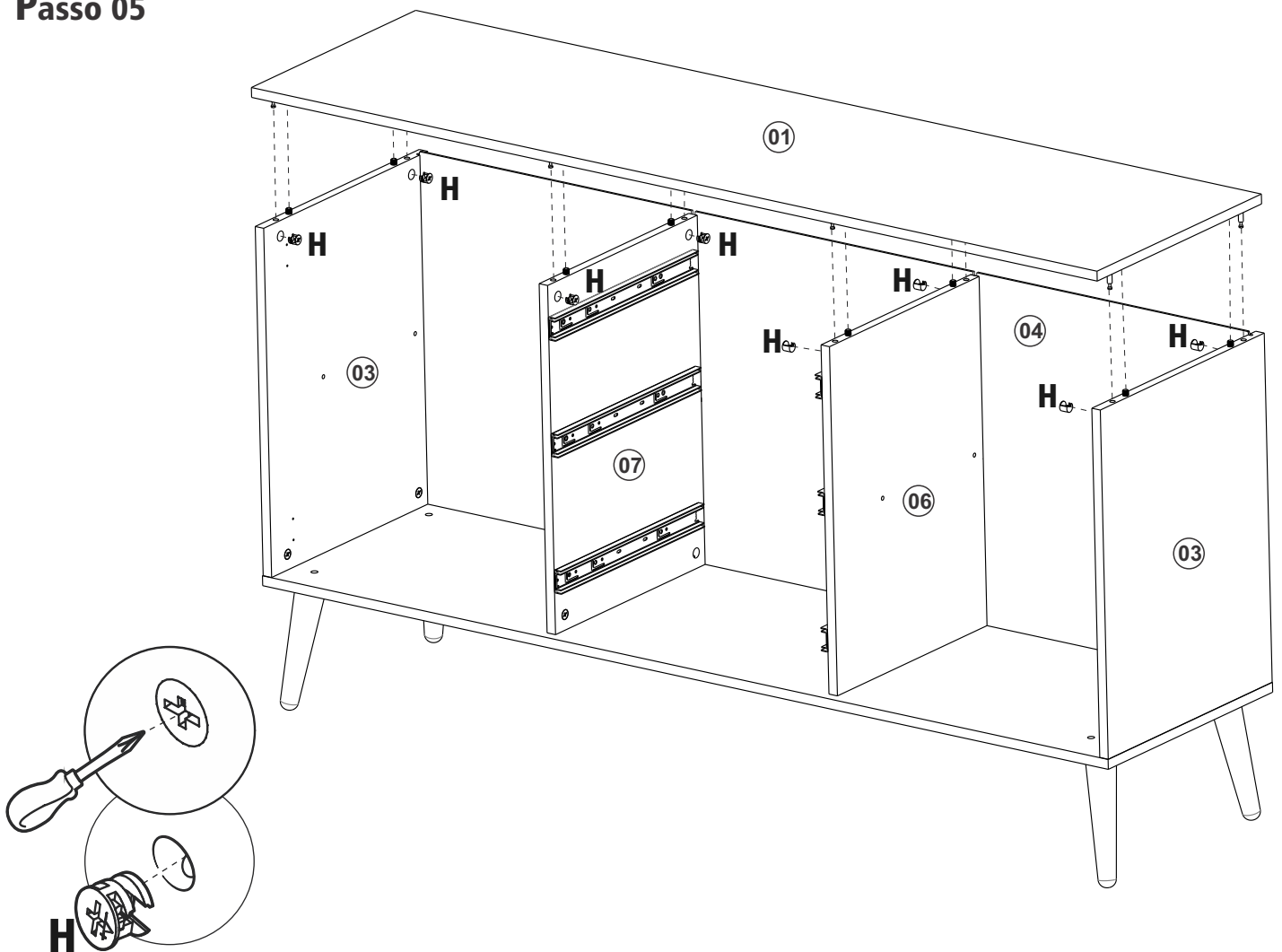

Passo 06

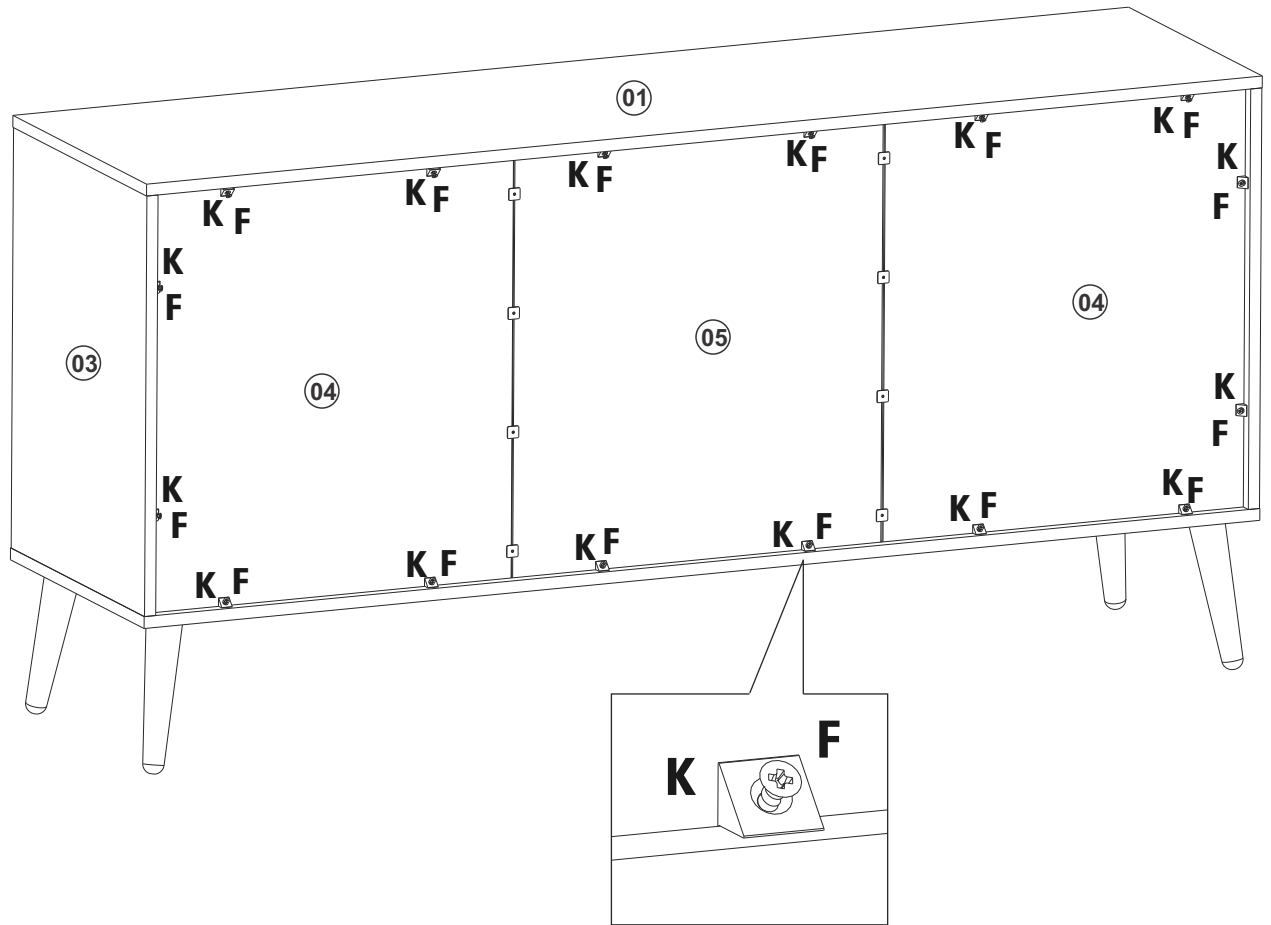

Passo 07

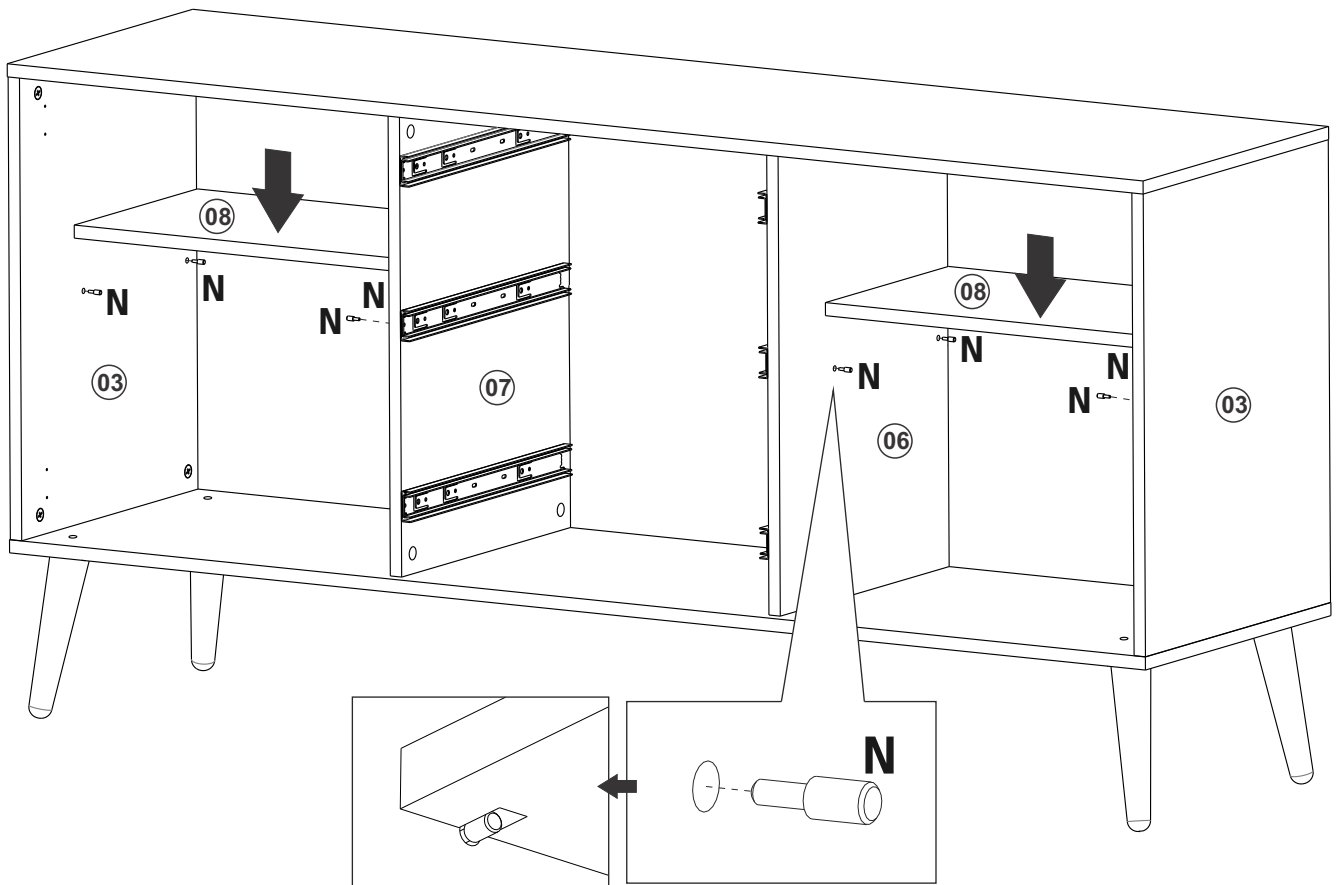

Passo 08 **2x**

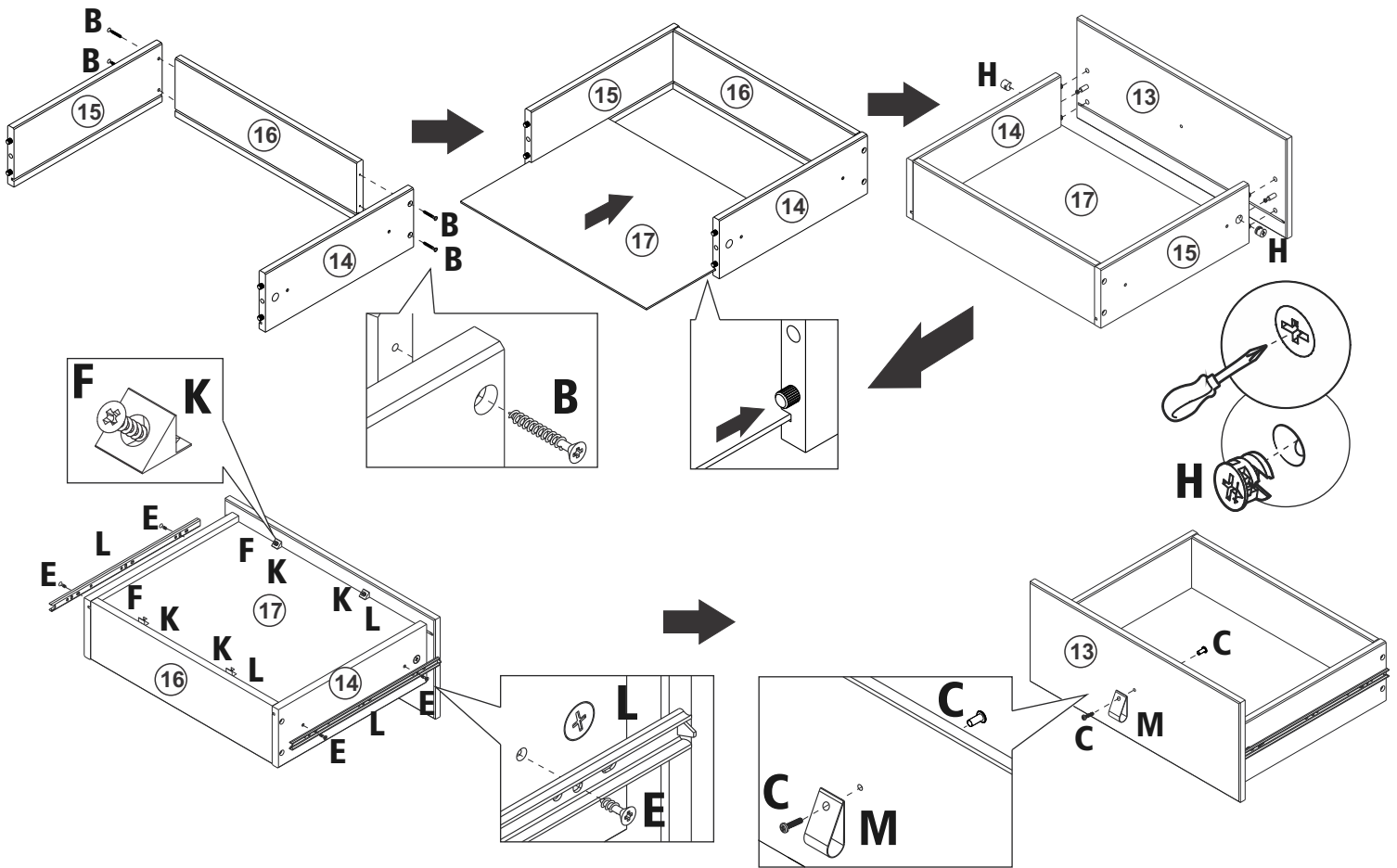

Passo 09

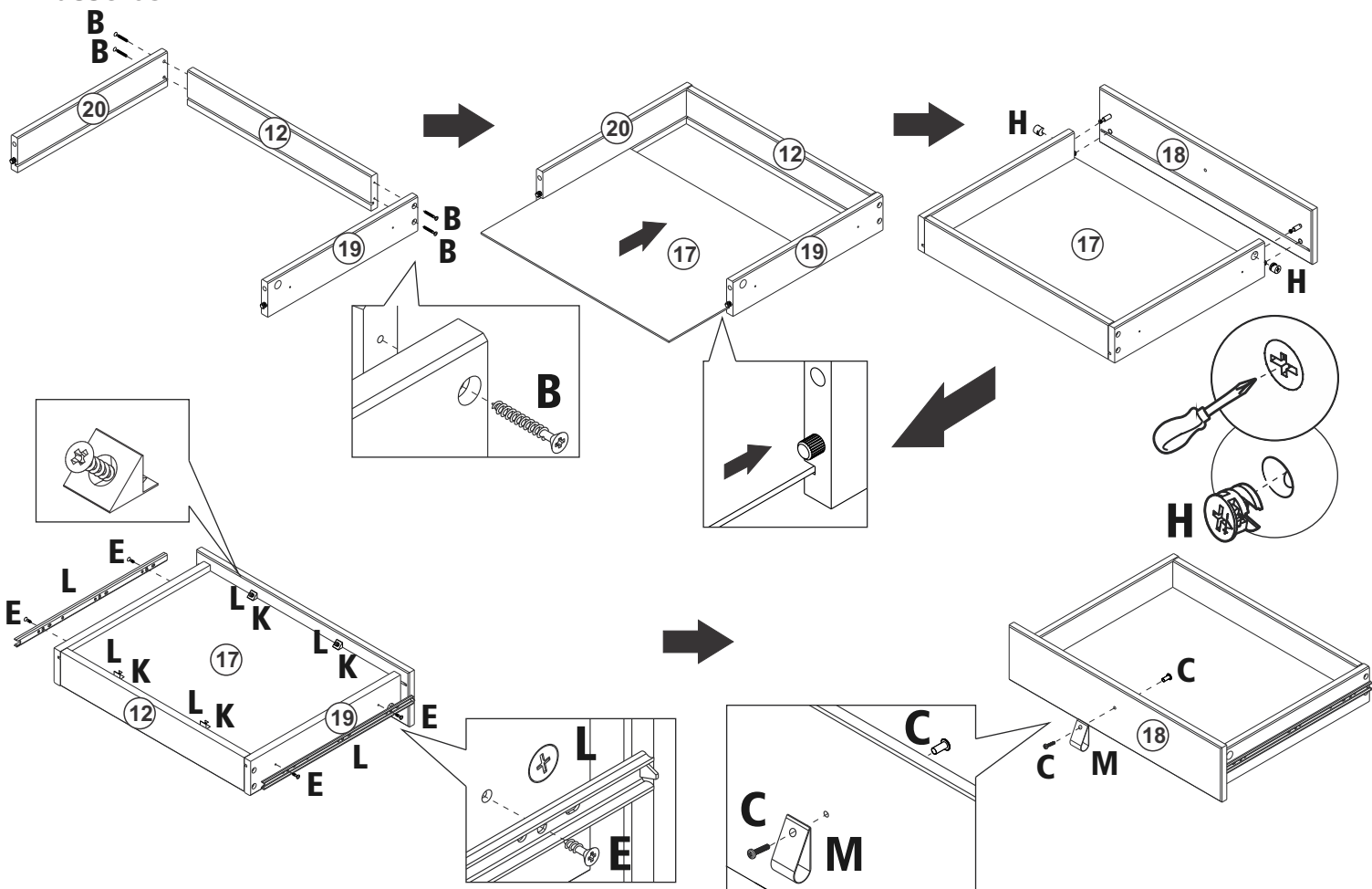

Passo 10

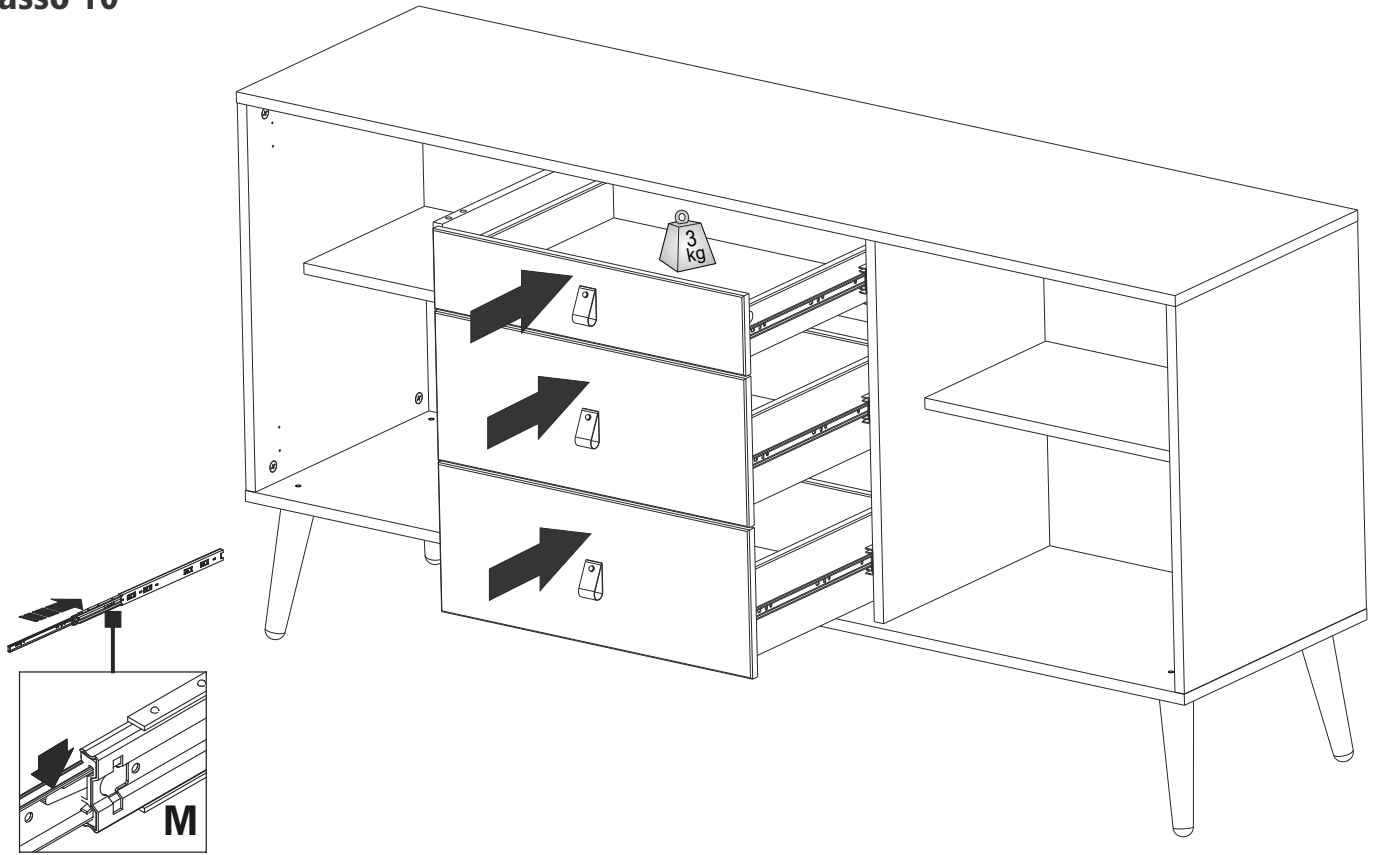

Passo 11

