

Esquema de Montagem

Estante Quadra Prateleiras

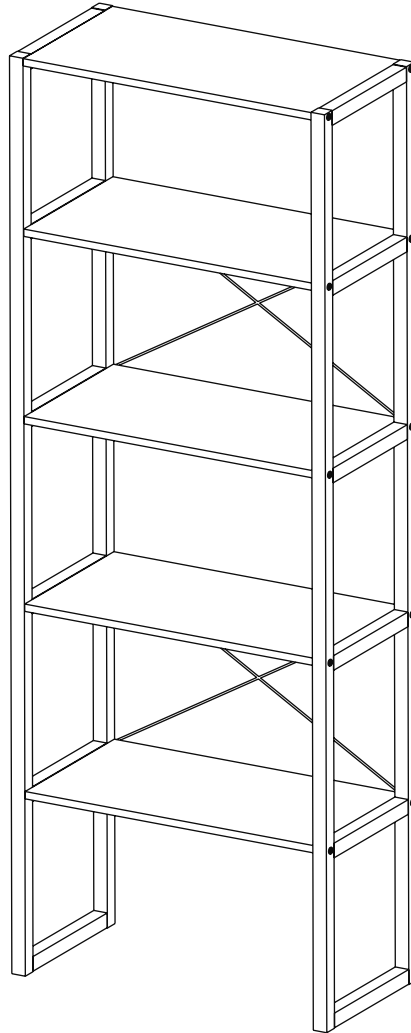

ferramentas necessárias
(não fornecidas)







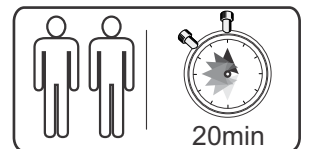

chave phillips

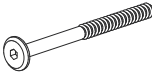

martelo de borracha

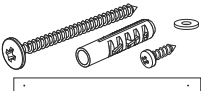

Ferragens

A		7 x 60	20
B		3,5 x 14	08
C		Chave Allen	01
D		Sapata Deslizante	04
E		Kit Antitombamento	01
F		Trava de Metal	04

Componentes

N.	Componentes	Quant.
01	Lateral Montada	02
02	Prateleira	05

⚠ Atenção!

Forrar o chão com o papelão das embalagens para efetuar a montagem.

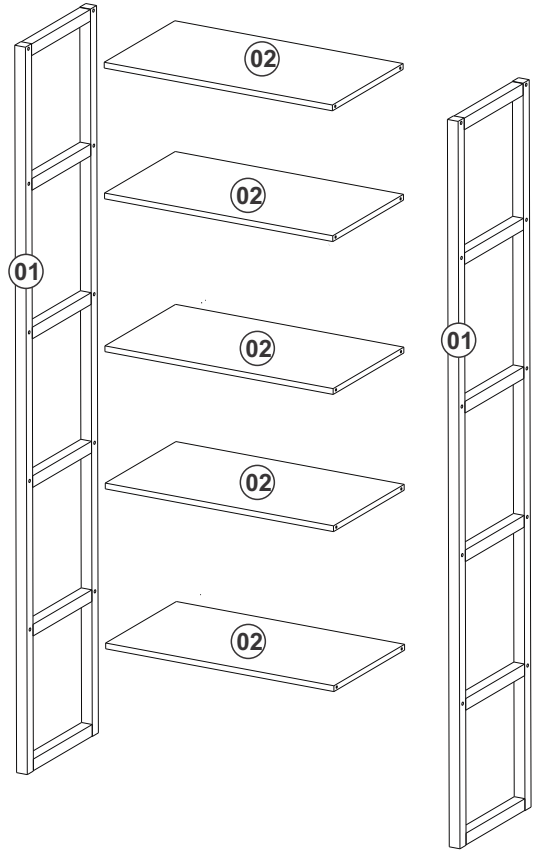
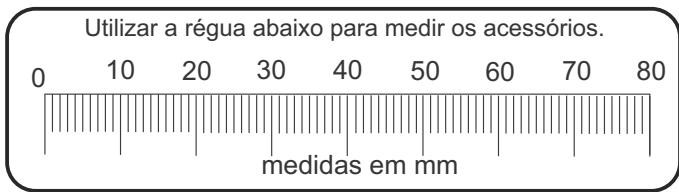

Passo 01

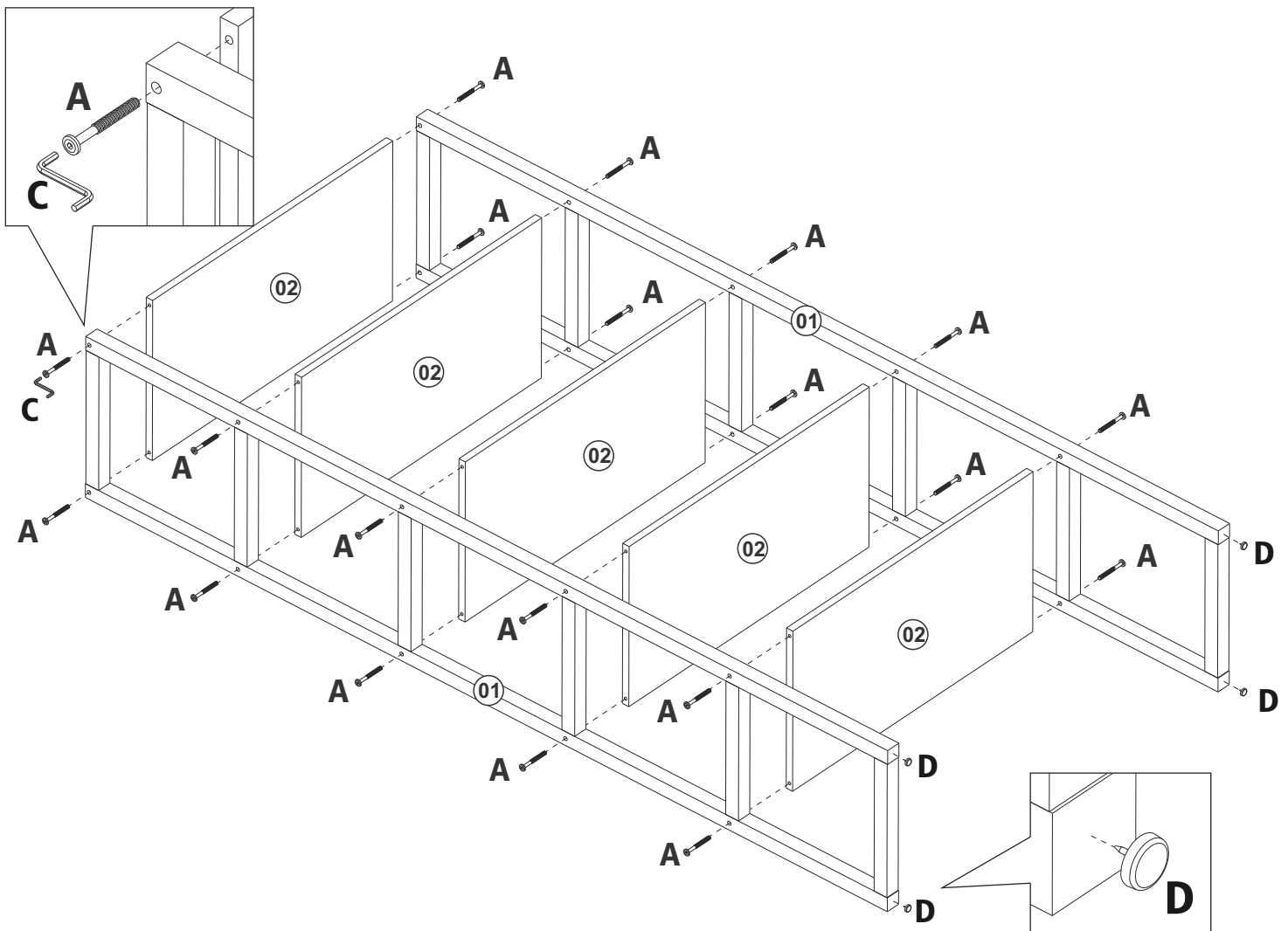

Passo 02

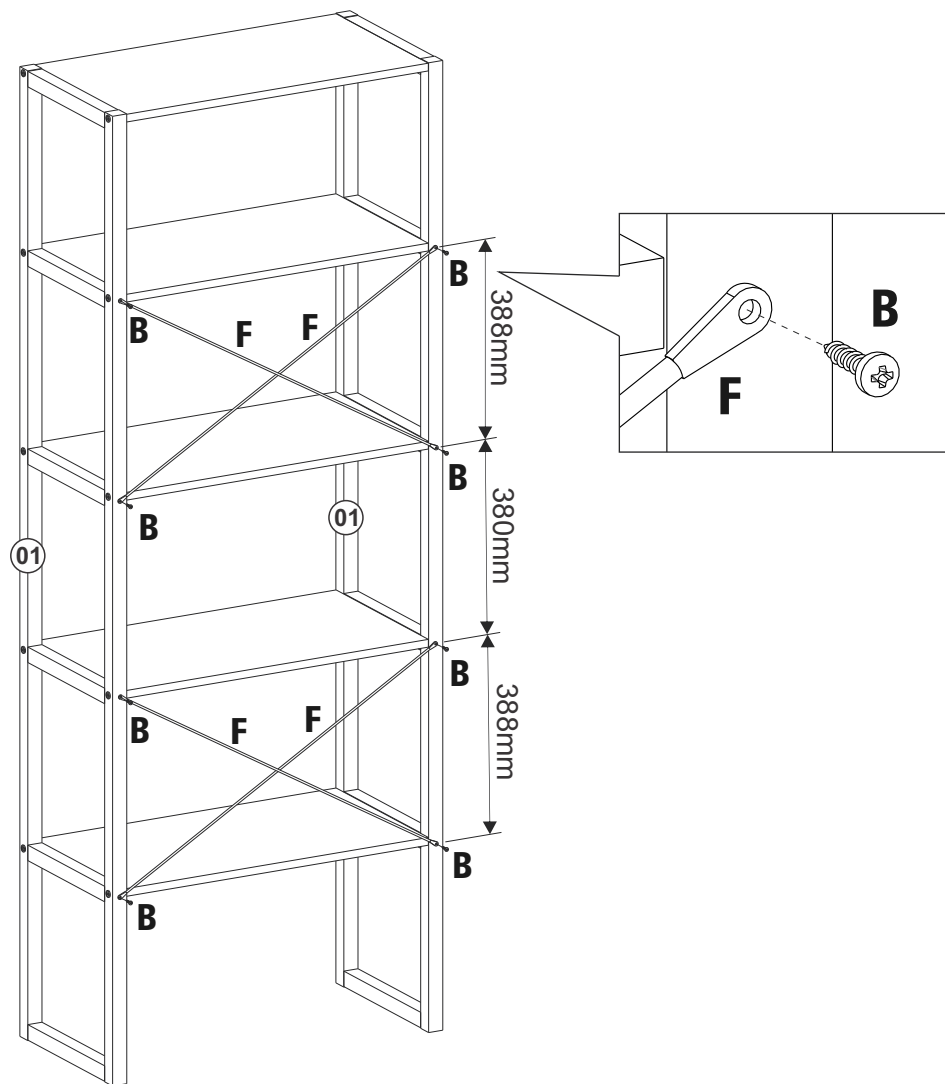

Passo 03

