

Esquema de Montagem

Sapateira Ivvie 4P



ferramentas necessárias
(não fornecidas)



chave phillips





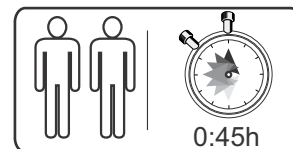





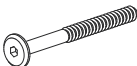



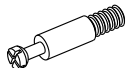

martelo de borracha

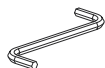

0:45h

Ferragens

A		7 x 50	04
B		5/32 x 5/8	04
C		4,0 x 16	32
D		3,0 x 16	16
E		Rapid Minifix	12
F		Tambor Minifix	12
G		Ø8x30	12
H		Ø6x30	04
I		Chave Allen	01

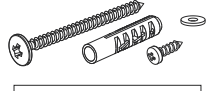
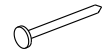
J		Rv8	16
K		Puxador	04
L		Suporte Prateleira	16
M		Dobradiça Super Curva	08
N		Chapa União	05
O		Kit Antitombamento	01
P		Prego	05

Componentes

N.	Componentes	Quant.
01	Tampo	01
02	Fundo	01
03	Lateral	02
04	Divisão	01
05	Prateleira	04
06	Porta Direita	02
07	Porta Esquerda	02
08	Traseiro	02
09	Pé	04

⚠ Atenção!

Forrar o chão com o papelão das embalagens para efetuar a montagem.

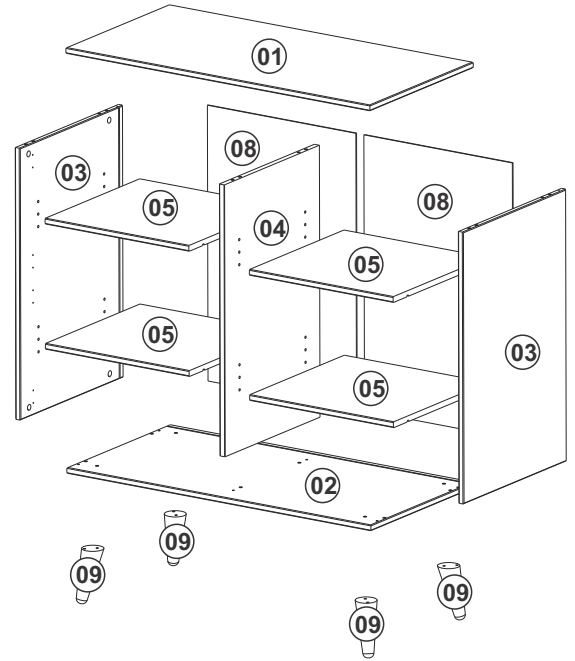
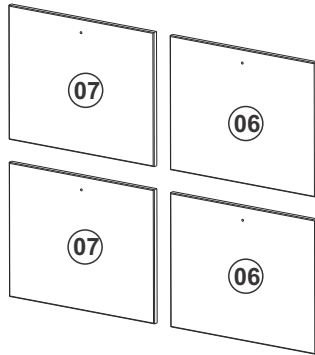

Utilizar a régua abaixo para medir os acessórios.

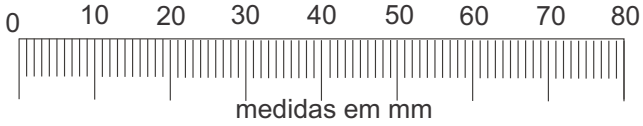

Passo 01

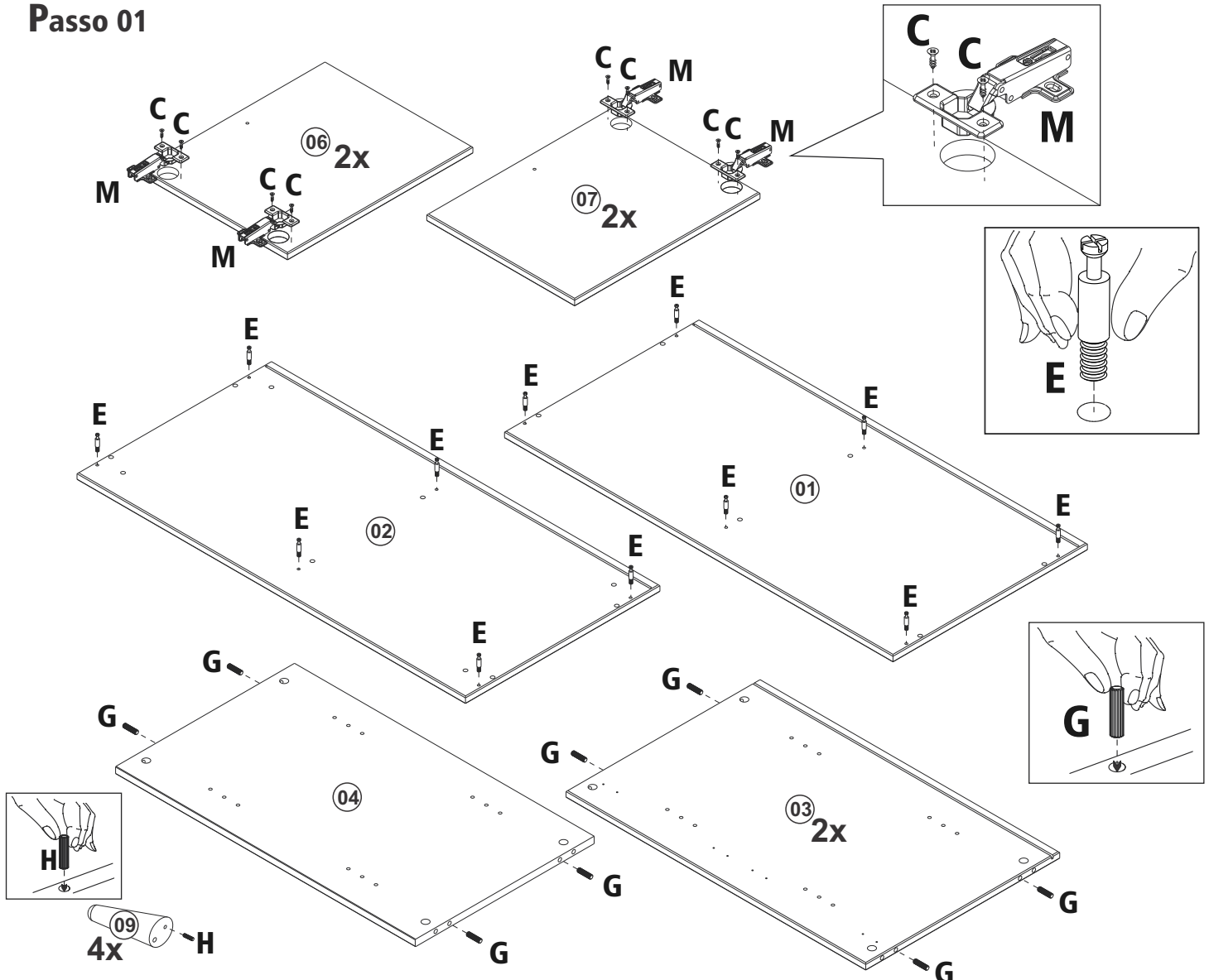

Passo 02

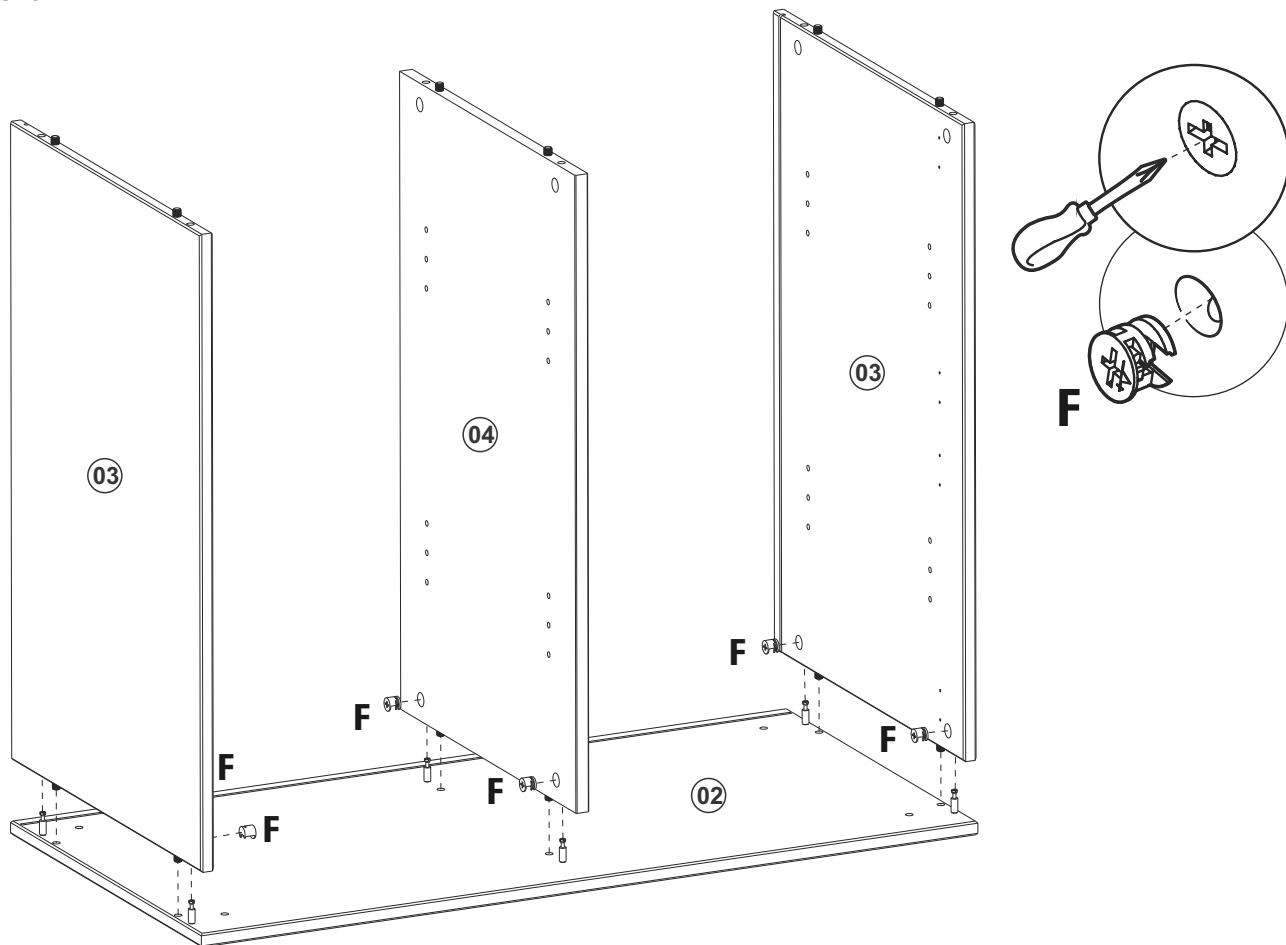

Passo 03

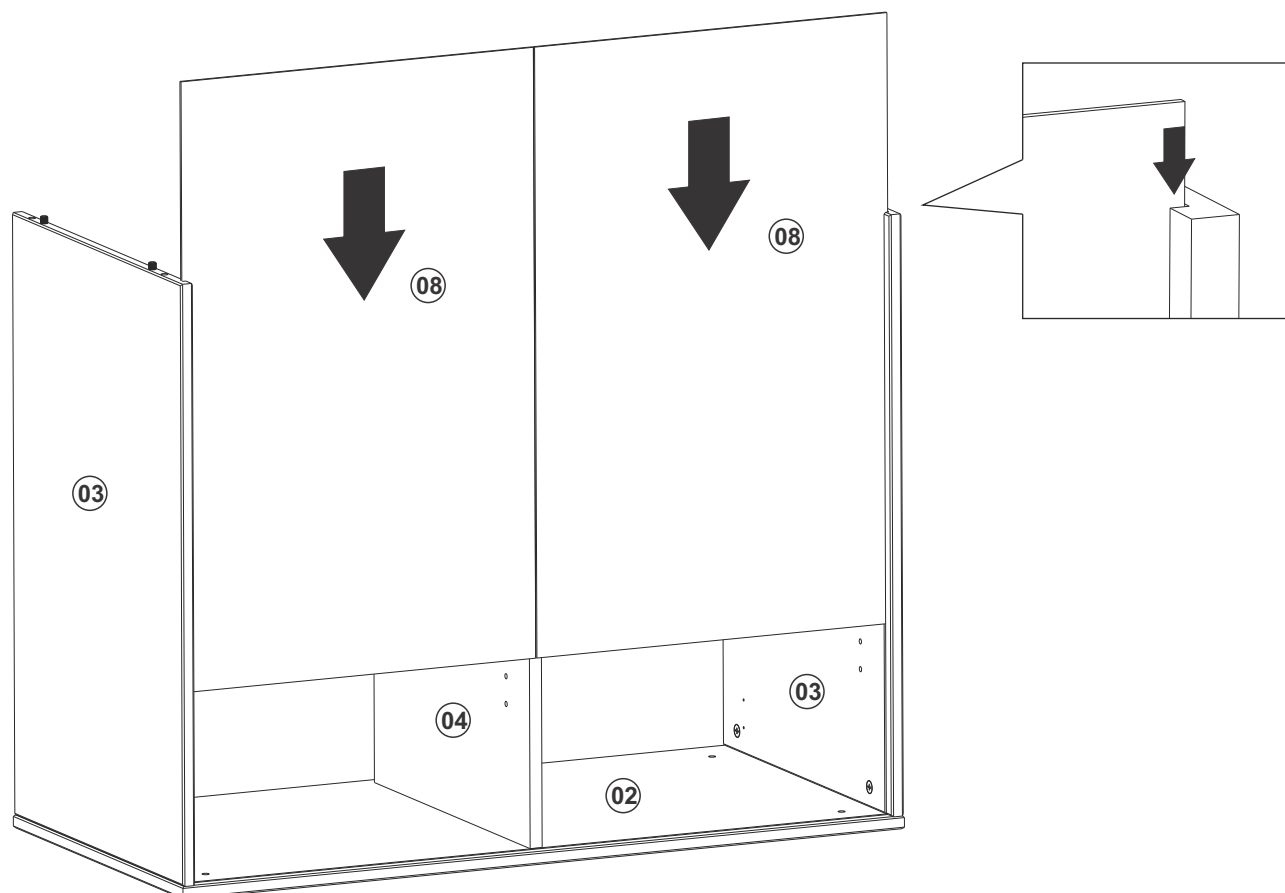

Passo 04

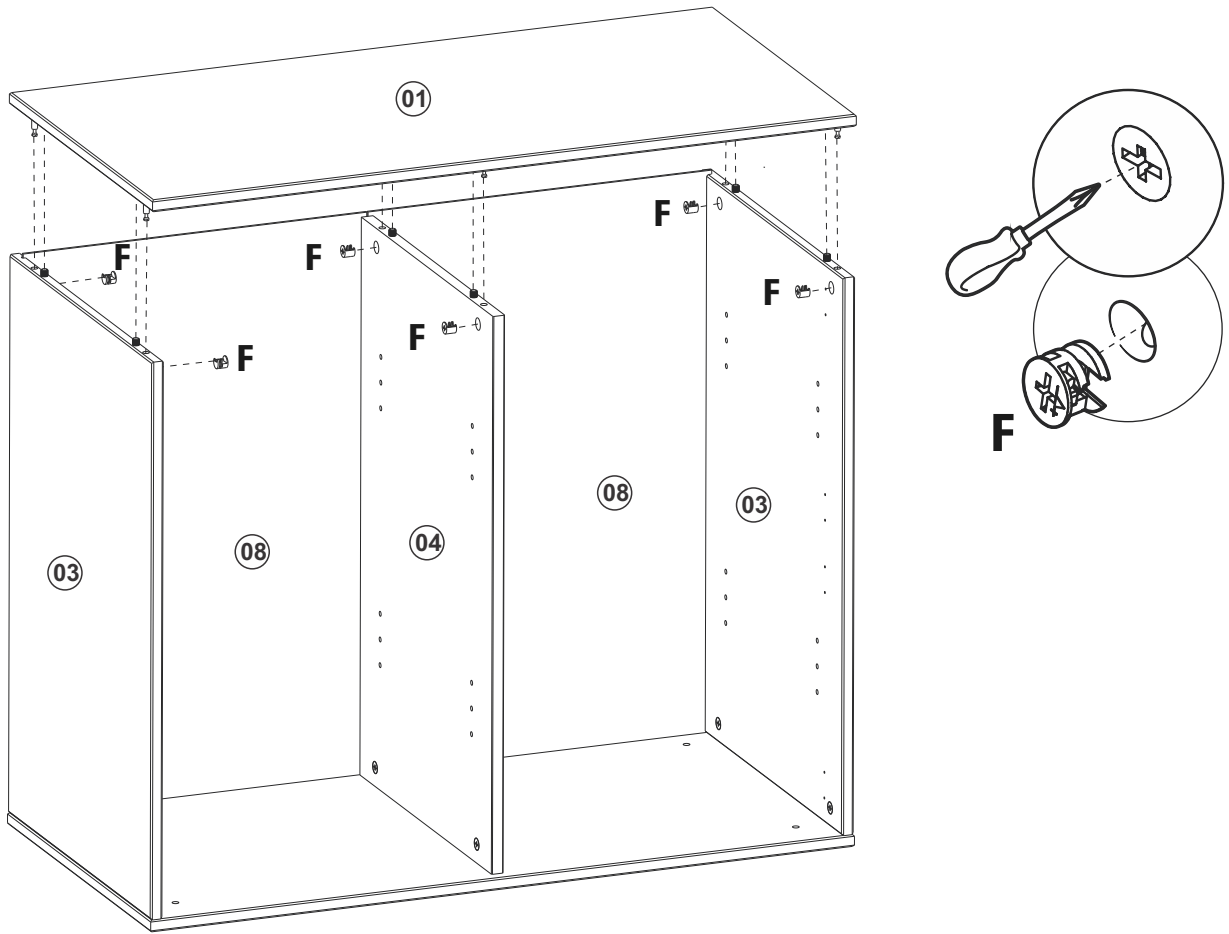

Passo 05

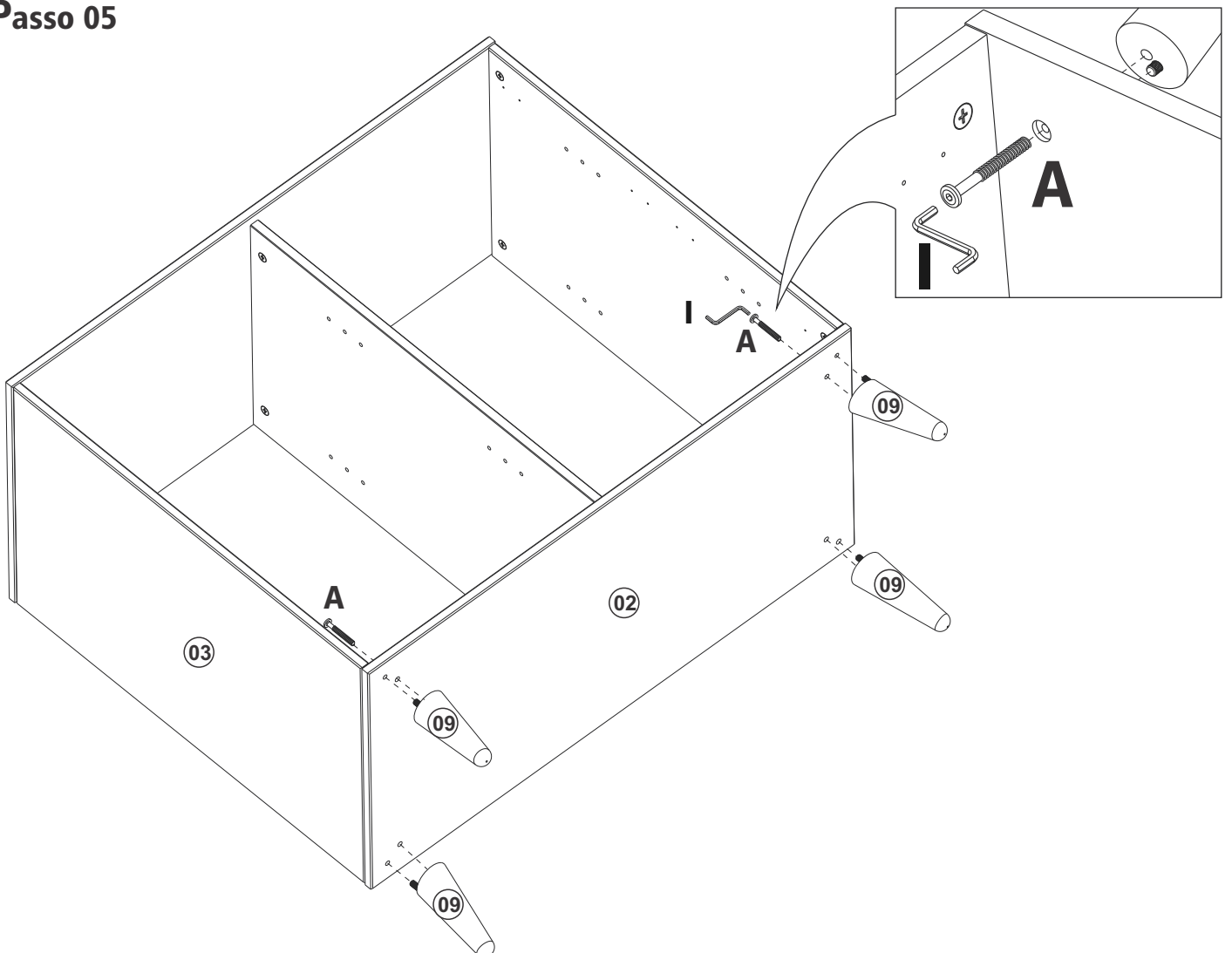

Passo 06

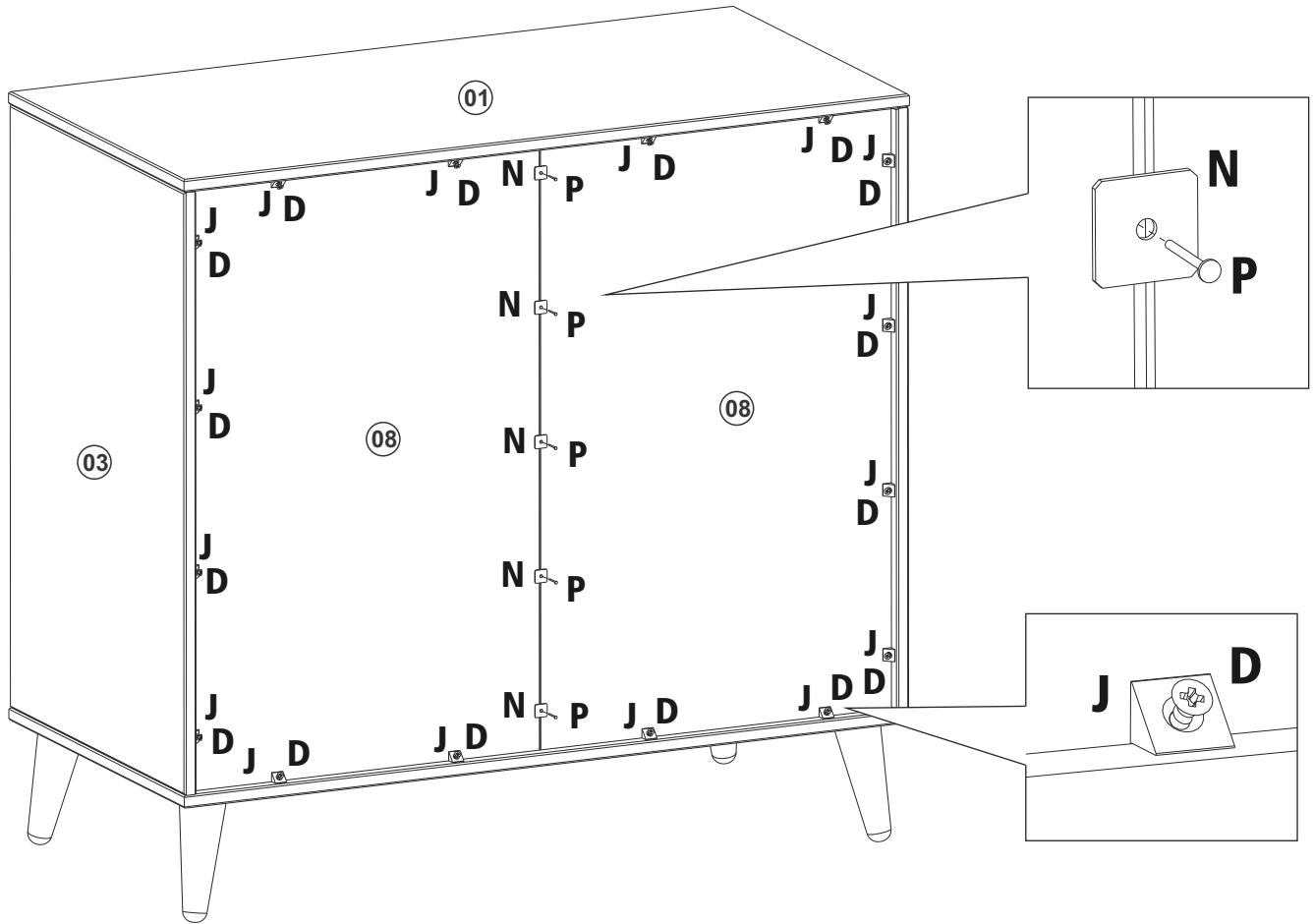

Passo 07

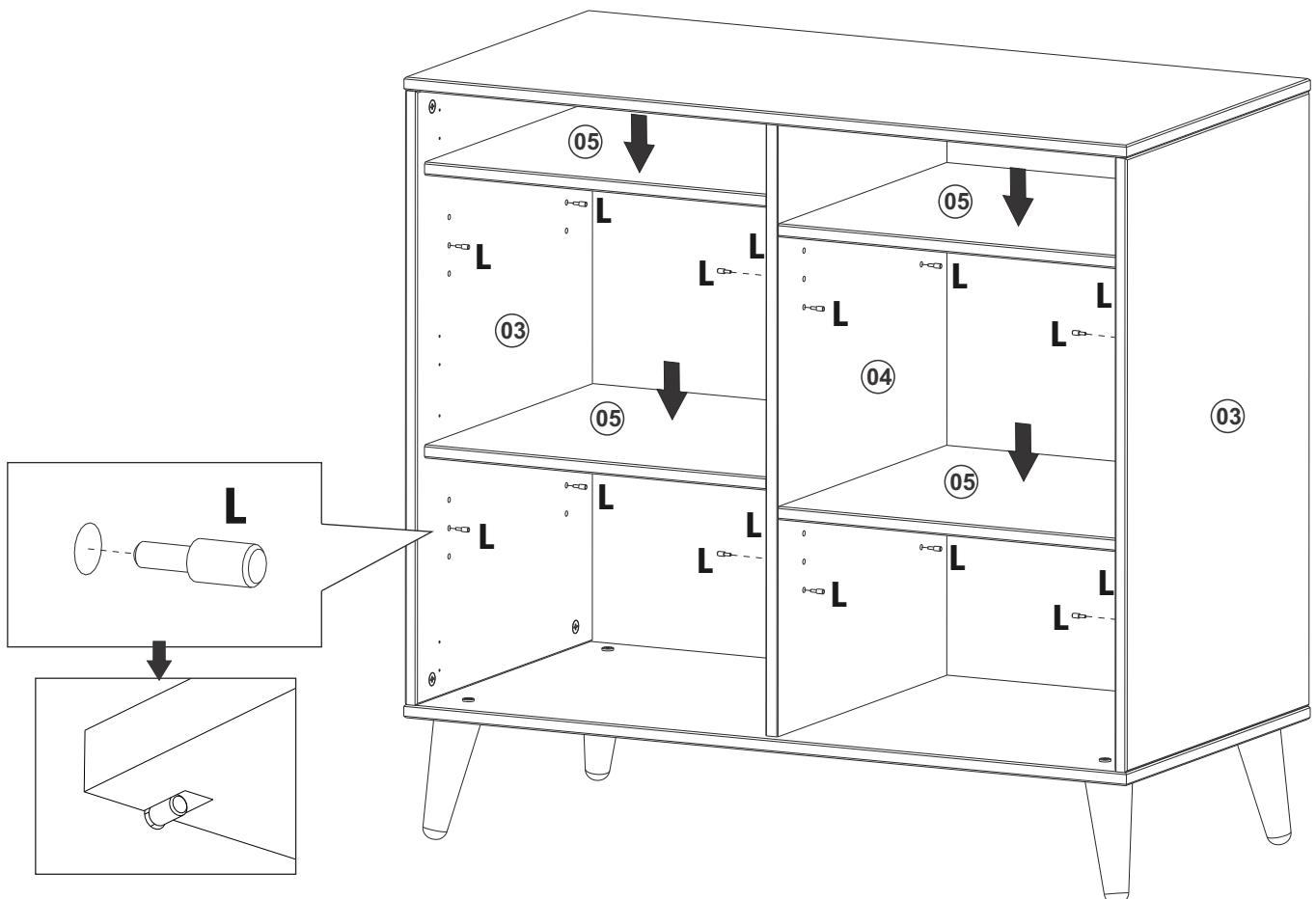

Passo 08

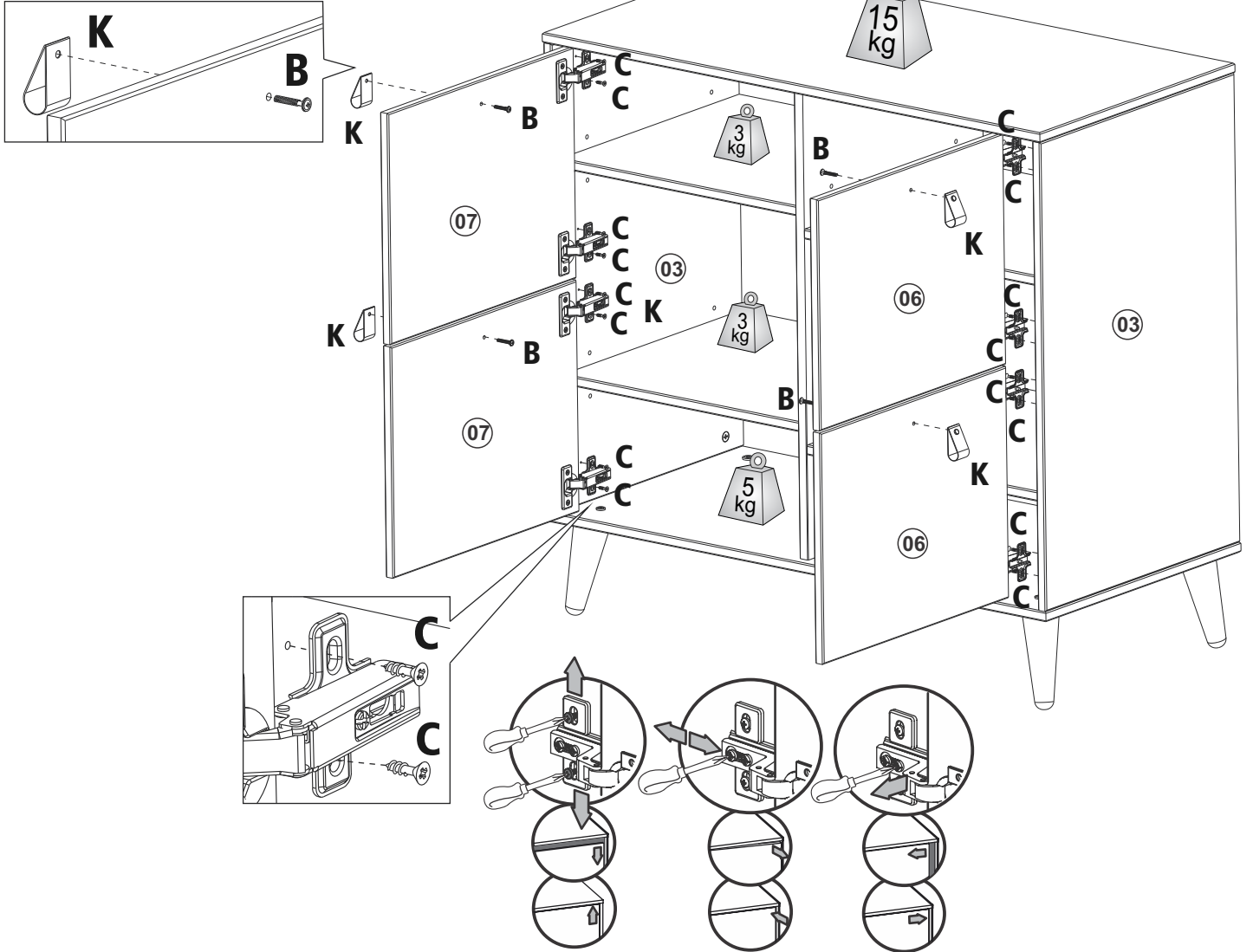

Passo 09

