

Esquema de Montagem

Mesa 800mm Linha Gold

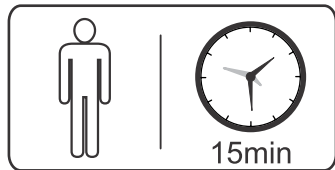
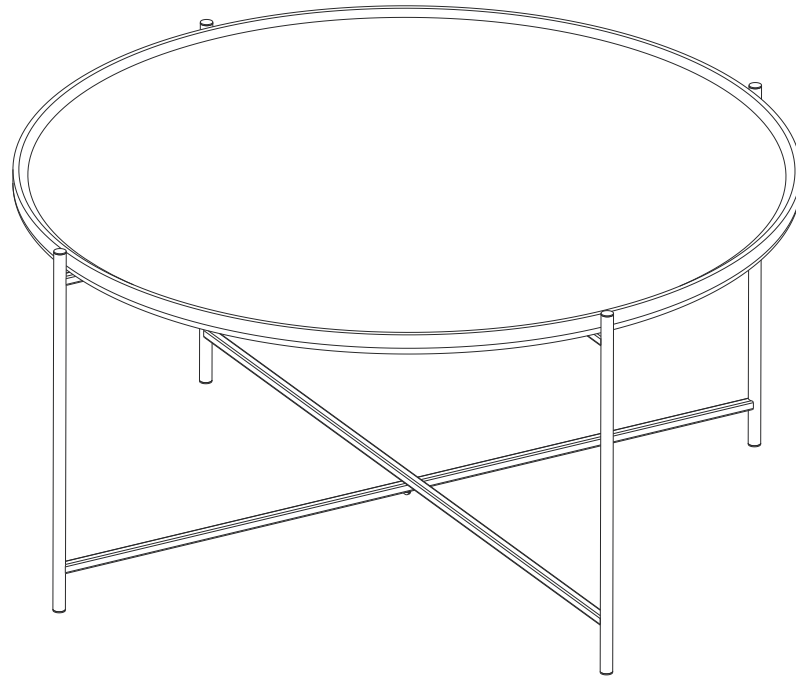

Ferragens

A



Ø4 x 20 **07**

B

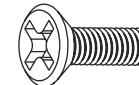

M4x20

01

Nº.	Componentes	Quant.
01	Tampo	01
02	Lateral A Base	01
03	Lateral B Base	01

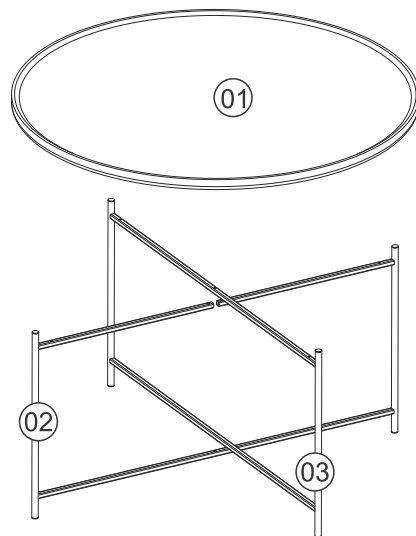

⚠ Atenção!

Forrar o chão com o papelão das embalagens para efetuar a montagem.



02

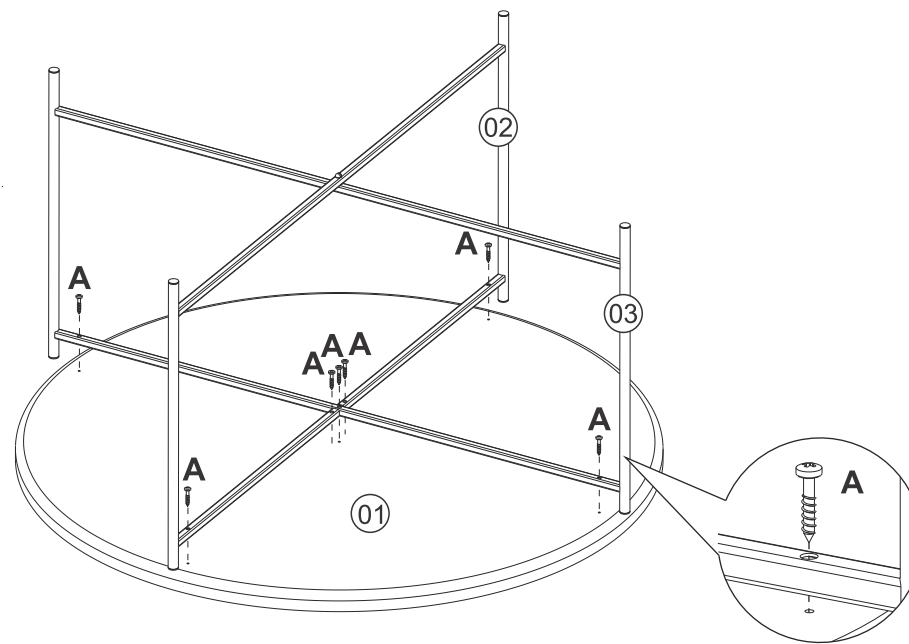

01

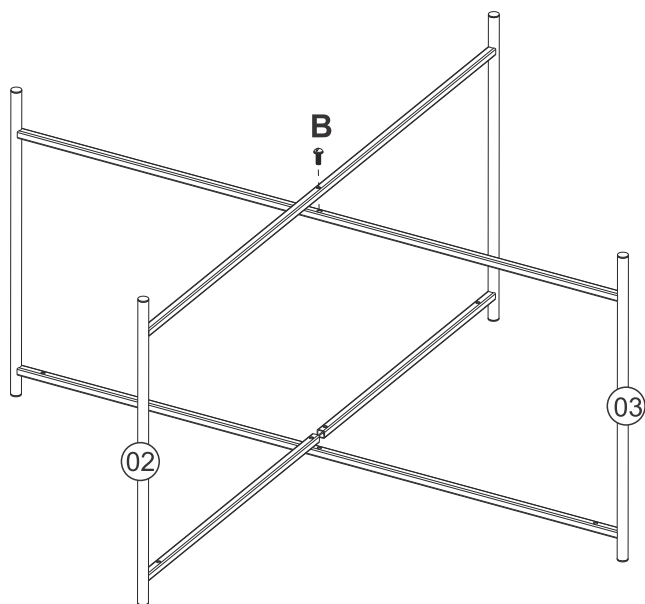

03

